

IN.05.062 - COPLAN 175

DOBRADIÇA OCULTA COM AJUSTE 3D /
CONCEALED HINGE WITH 3D ADJUSTMENT /
BISAGRA OCULTA CON AJUSTE 3D /
CHARNIÈRE OCCULT AVEC 3D RÉGLAGE

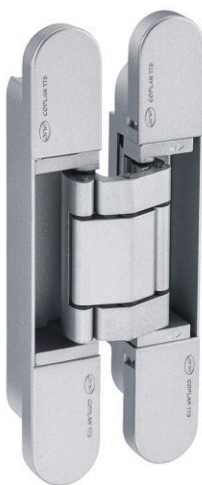

COPLAN 245



COPLAN 175



COPLAN 150



IN.05.062 - COPLAN 175

COMPONENTES / Components /
Componentes / Composants

EN 1935

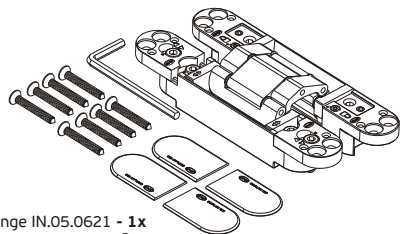

3D Hinge IN.05.0621 - **1x**
Fixing screws - **8x**
Plastic covers - **4x**
Allen key - **1x**

IN.05.062

EN1935 **3 7 4 0 1 4 0 11**

IN.05.062 + KI.05.062

**Dobradiça invisível com ajuste 3D + kit
intumescente/**

3D Adjustable invisible hinge + intumescent kit /

EN1935 **3 7 4 1 1 1 4 0 11**

FERRAMENTA OPCIONAL / Tooling Optional
Herramienta Opcional / Outillage Optionnel

OPCIONAL /
Optional / Opcional / Optionnel

IN.08.061.T

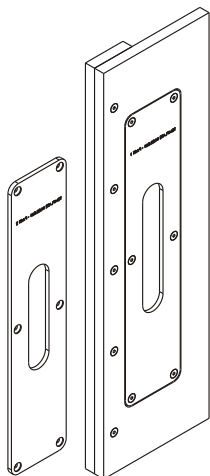

IN.05.062.C

Tampas em aço inox com parafusos /

Stainless steel covers with screws /

Cubiertas en acero inoxidable con tornillos /

Coverture en acier inoxydable avec vis /

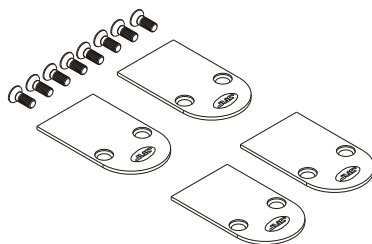

WARNINGS

Não recomendado o uso de molas de porta com sistema de retenção /

Not recommended to use door closers with restraint system /

No se recomienda utilizar cierrapuertas con sistema de retención /

Pas recommandé d'utiliser des ferme-portes avec système de retenue /

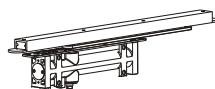

As afinações nos 3 eixos devem ser efectuadas em um eixo de cada vez.

Fazer pequenos ajustes nos parafusos de afinação alternando de dobradiça em dobradiça./

The adjustments in 3 axes must be carried out on one axis at a time.

Make small adjustments to the adjusting screws alternating hinge on hinge. /

Los ajustes en los 3 ejes deben llevarse a cabo en un eje a la vez.

Hacer pequeños ajustes a los tornillos de ajuste y alternar de bisagra en bisagra. /

Les ajustements des 3 axes doivent être effectués sur un axe à la fois.

Effectuer de petits réglages à vis de réglage alternance charnière en charnière. /

Especificações da porta /

Door specifications / Especificaciones puerta / Spécifications de porte

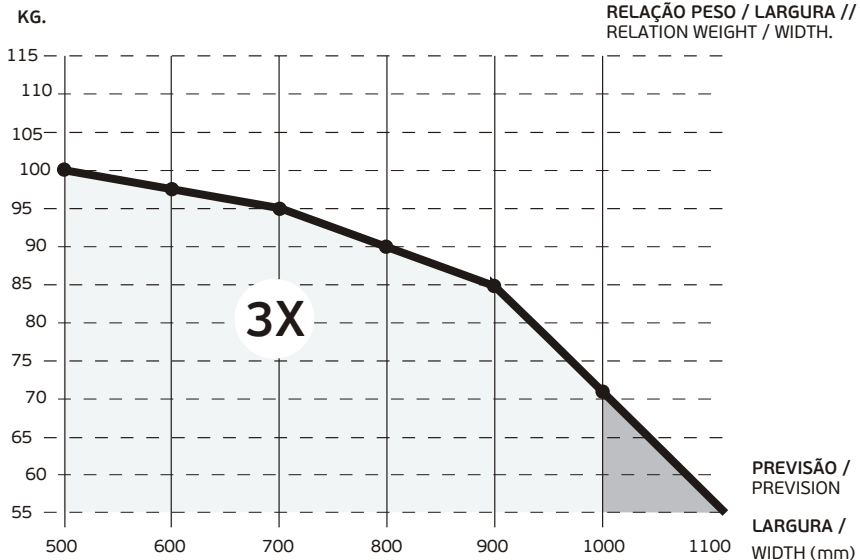

AJUSTES / Adjustments / Ajustes / Ajustements

Distribuição / Distribution / Distribución / Répartition

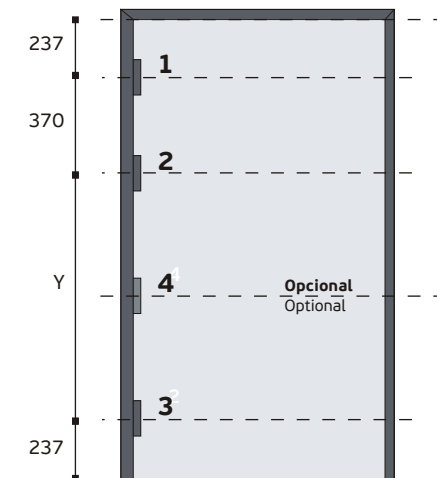
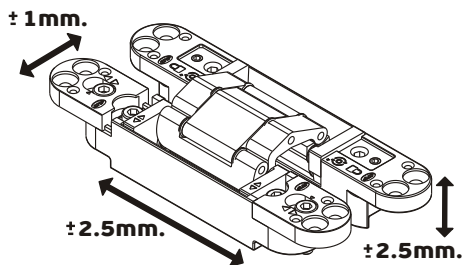

Dimensões /
 Dimensions / Dimensiones / Dimensions

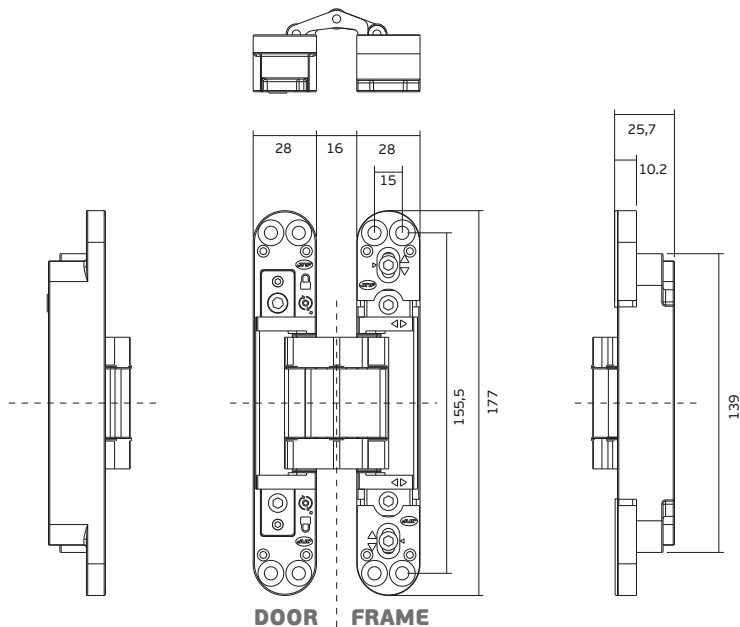

Entalhes /
 Cut out / Taladros / Découpe

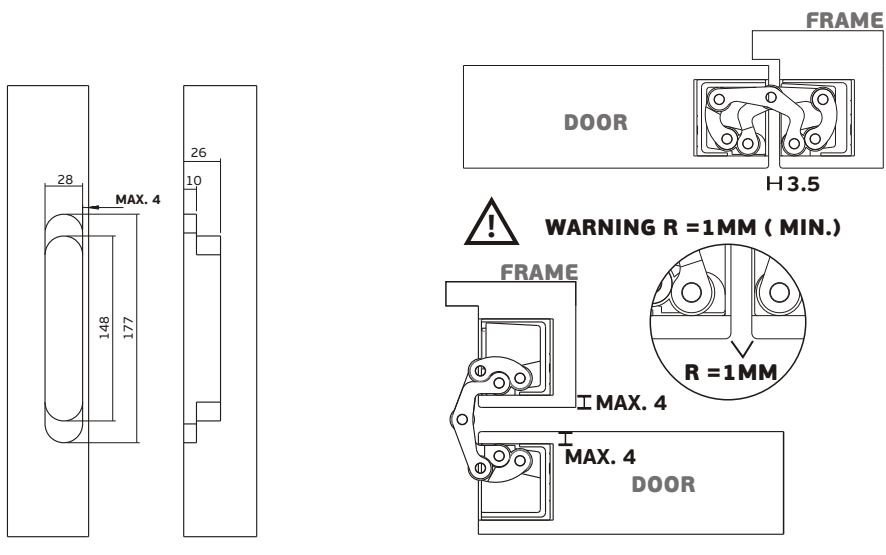

Ajustes / Adjustments / Ajustes / Ajustements

PT

- 1** Ajuste em profundidade. Aliviar os 2 parafusos de cada dobradiça. Ajustar a posição da porta. Apertar todos os parafusos, torque 3 N/m. /
- 2** Ajuste vertical. Aliviar os 2 parafusos de cada dobradiça. Inserir um calço na parte inferior da porta com a folga pretendida. Apertar todos os parafusos, torque 3 N/m. /
- 3** Ajuste horizontal. Aliviar os parafusos (3.1) de cada dobradiça. Rodar alternadamente os parafusos (3) de forma a conseguir a folga desejada. Para bloquear o ajuste apertar todos os parafusos (3.1), torque 3 N/m. /

EN

- 1** Depth adjustment. Loose the 2 screws of each hinge. Adjust the position of the door. Tighten all screws, torque 3 N/m. /
- 2** Vertical adjustment. Loose the 2 screws of each hinge. Place a shim in the lower part of the door with the desired gap. Tighten all screws, torque 3 N/m. /
- 3** Horizontal adjustment. Loose the screws (3.1) of each hinge. Turning alternately the screws (3) in order to achieve the desired gap. To lock the adjustment tighten all the screws (3.1) Torque 3 N/m. /

ES

- 1** Ajuste de profundidad. Afloje los 2 tornillos de cada bisagra. Ajuste la posición de la puerta. Apriete todos los tornillos, esfuerzo de torsión 3 N/m. /
- 2** Ajuste vertical. Afloje los 2 tornillos de cada bisagra. Coloque la cuña en la parte inferior de la puerta con el hueco deseado. Apriete todos los tornillos, esfuerzo de torsión 3 N/m. /
- 3** Ajuste horizontal. Afloje los tornillos (3.1) de cada bisagra. Rodar alternativamente los tornillos (3) con el fin de lograr el separación deseada. Para bloquear el ajuste de apretar todos los tornillos (3.1) esfuerzo de torsión 3 N / m. /

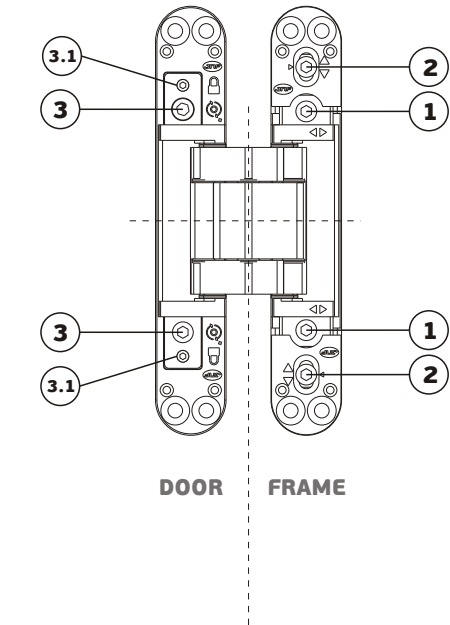

FR

- 1** Réglage de la profondeur. Desserrez les 2 vis de chaque charnière. Ajustez la position de la porte. Serrez toutes les vis, couple 3 N/m. /
- 2** Réglage vertical. Desserrez les 2 vis chaque charnière. Placer une cale dans la partie inférieure de la porte à l'écart souhaité Serrez toutes les vis, couple 3 N/m. /
- 3** Réglage horizontal. Desserrez les vis (3.1) de chaque charnière. Tournage en alternance les vis (3) afin de parvenir à la écart souhaitée. Pour verrouiller le réglage serrez toutes les vis (3.1) Couple 3 N / m. /

Tampas / Covers /
Cobiertas / Couvertures

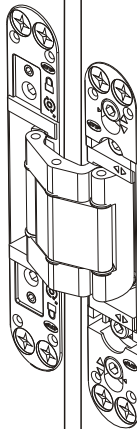
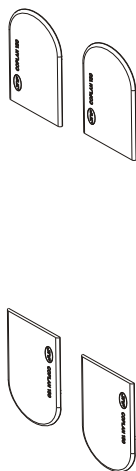

Tampas / Covers /
Cobiertas / Couvertures

OPCIONAL /
Optional / Opcional / Optionnel

IN.05.062.C

Tampas em aço inox com parafusos.
Com uma aparafusadora aplicar diretamente os parafusos fornecidos
Utilizar bit TX10. /
 Stainless steel covers with screws.
 With a screwdriver directly apply the supplied screws
 Use bit TX10./
 Cubiertas en acero inoxidable con tornillos.
 Con un destornillador de aplicar directamente los tornillos suministrados
 Uso bit TX10./
 Couverture en acier inoxydable avec vis.
 Avec un tournevis appliquer directement les vis fournies
 Utiliser le bit TX10. /

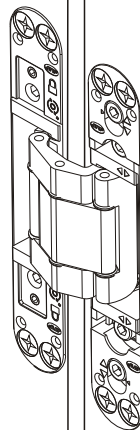
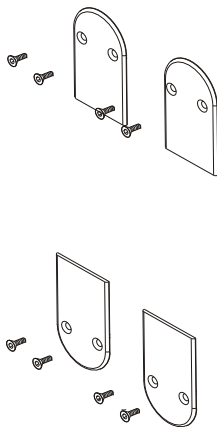
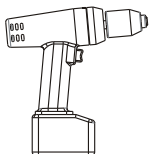



J. Neves & Filhos
Comércio e Indústria de Ferragens, S.A.

Rua das Mimosas, 849/851
Zona Industrial das Mimosas
S. Pedro da Cova | Ap. 75
4424-909 Gondomar PORTUGAL